



## Selection: Semi-hermetic Reciprocating Compressors

### Input Values

Compressor model	(6H-25.2Y)	Suct. gas superheat	10,00 K
Mode	Refrigeration and Air conditioning	Operating mode	Auto
Refrigerant	R404A	Power supply	400V-3-50Hz
Reference temperature	Dew point temp.	Capacity control	100%
Liq. subc. (in condenser)	0 K	Useful superheat	7,00 K

### Result

Q [W]	Cooling capacity	COP [ - ]	COP/EER
Qu* [W]	Evaporator capacity	m [kg/h]	Mass flow
P [kW]	Power input	Op.	Operating mode
I [A]	Current	th [°C]	Discharge gas temp. w/o cooling
Qc [W]	Condenser capacity		

tc	to	-5°C	-10°C	-15°C	-20°C	-25°C	-30°C	-35°C	-40°C
<b>30°C</b>	Q [W]	84543	68723	55276	43907	34353	26381	19782	14372
	Qu* [W]	82668	67205	54057	42939	33595	25797	19342	14050
	P [kW]	23,5	22,1	20,6	18,83	16,94	14,95	12,89	10,81
	I [A]	39,7	37,6	35,2	32,6	29,8	27,0	24,2	21,5
	Qc [W]	108043	90873	75856	62738	51294	41330	32676	25186
	COP [ - ]	3,52	3,03	2,63	2,28	1,98	1,73	1,50	1,30
	m [kg/h]	2358	1961	1615	1315	1056	833	642	480
	Op.	Standard	Standard	Standard	Standard	Standard	Standard	Standard	Standard
	th [°C]	55,7	57,4	59,4	61,8	64,6	68,1	72,2	77,4
	<b>40°C</b>	Q [W]	70628	57021	45483	35755	27601	20815	15216
Qu* [W]		68838	55576	44329	34845	26895	20278	14820	10366
P [kW]		27,2	25,2	23,0	20,7	18,28	15,83	13,36	10,92
I [A]		45,5	42,3	38,9	35,4	31,8	28,2	24,8	21,7
Qc [W]		97836	82208	68483	56440	45882	36641	28575	21565
COP [ - ]		2,53	2,21	1,93	1,68	1,47	1,28	1,11	0,95
m [kg/h]		2252	1866	1529	1237	983	765	578	418
Op.		Standard	Standard	Standard	Standard	Standard	Standard	Standard	Standard
th [°C]		67,7	69,5	71,7	74,4	77,5	81,4	86,4	93,1
<b>50°C</b>		Q [W]	--	45213	35676	27665	20991	15486	10997
	Qu* [W]	--	43853	34595	26820	20342	15000	10646	7148
	P [kW]	--	27,8	25,0	22,2	19,31	16,43	13,59	10,83
	I [A]	--	46,4	42,1	37,7	33,3	29,0	25,1	21,6
	Qc [W]	--	72999	60701	49851	40300	31916	24588	18217
	COP [ - ]	--	1,58	1,38	1,21	1,05	0,91	0,78	0,66
	m [kg/h]	--	1757	1432	1149	904	692	511	358
	Op.	--	Standard	Standard	Standard	Standard	Standard	Standard	Standard
	th [°C]	--	82,2	84,6	87,6	91,2	95,8	101,8	110,3



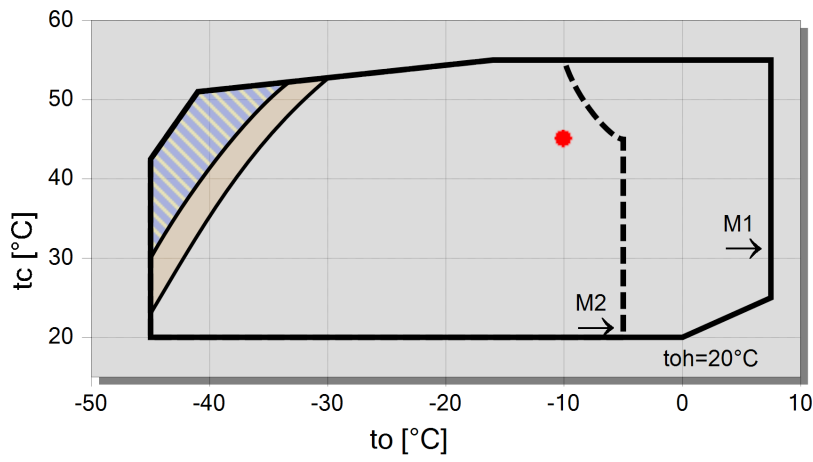

-- No calculation possible (see message in single point selection)

\*According to EN12900 (20°C suction gas temp., 0K liquid subcooling)

## Application Limits 100%



**Legend**

-  additional cooling & suction gas superheat  $\leq 20K$
-  additional cooling or max. toh  $< 0^\circ C$
-  M1: motor 1
-  M2: motor 2
-  A



## Technical Data: (6H-25.2Y)

### Dimensions and Connections

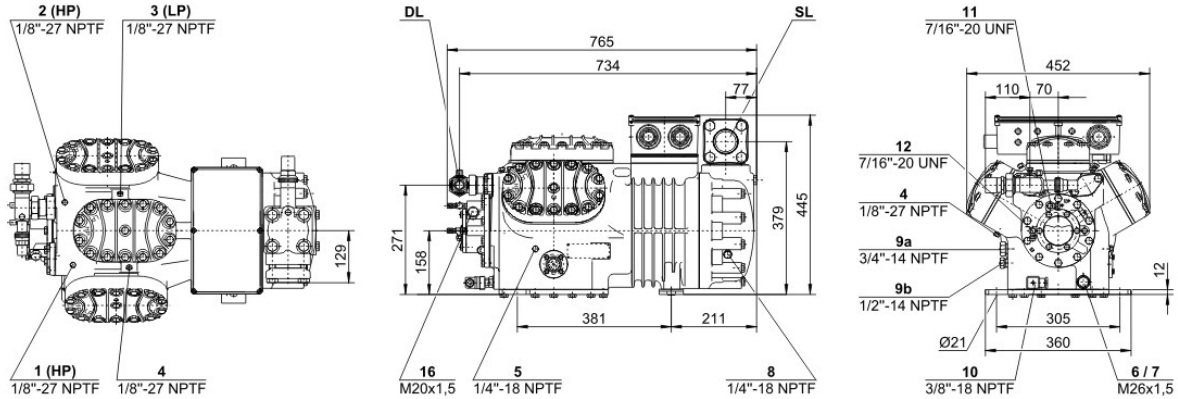

### Technical Data

#### Technical Data

Displacement (1450 RPM 50Hz)	110,5 m <sup>3</sup> /h
Displacement (1750 RPM 60Hz)	133,4 m <sup>3</sup> /h
No. of cylinder x bore x stroke	6 x 70 mm x 55 mm
Weight	224 kg
Max. pressure (LP/HP)	19 / 28 bar
Connection suction line	54 mm - 2 1/8"
Connection discharge line	35 mm - 1 3/8"
Connection cooling water	R 3/4"
Oil type R134a/R407C/R404A/R507A/R407A/R407F	tc<55°C: BSE32   tc>55°C: BSE55 (Option)
Oil type R22 (R12/R502)	B5.2 (Standard)
Oil type R290/R1270	SHC226E (Standard)

#### Motor data

Motor voltage (more on request)	380-420V PW-3-50Hz
Max operating current	45.0 A
Winding ratio	50/50
Starting current (Rotor locked)	116.0 A Y / 193.0 A YY
Max. Power input	28.9 kW

#### Extent of delivery (Standard)

Motor protection	SE-B2
Enclosure class	IP54 (Standard), IP66 (Option)
Vibration dampers	Standard
Oil charge	4,75 dm <sup>3</sup>

#### Available Options

Connection suction line	Option
Discharge shut-off valve	Option
Discharge gas temperature sensor	Option
Start unloading	Option
Capacity control	100-66-33% (Option)
Additional fan	Option
Water-cooled cylinder heads	Option
CIC System	Option
Oil service valve	Option
Crankcase heater	140 W (Option)
Oil pressure monitoring	MP54 (Option), Delta-PII (Option, not for R290/R1270)

#### Sound measurement

Sound power level (-10°C / 45°C)	82,0 dB(A) @ 50Hz
Sound power level (-35°C / 40°C)	90,5 dB(A) @ 50Hz
Sound pressure level @ 1m (-10°C / 45°C)	74,0 dB(A) @ 50Hz



Sound pressure level @ 1m (-35°C / 40°C)

82,5 dB(A) @ 50Hz



## Semi-hermetic Reciprocating Compressors

**Motor 1** = e.g. 4TES-12 with 12"HP", primary for air-conditioning (e.g. R22,R407C) and air-conditioning with R134a at high ambient temperatures.

**Motor 2** = e.g. 4TES-9 with 8"HP", universal Motor for medium and low temperature application (e.g. R404A, R507A, R407A, R407F) and air-conditioning with R134a

**Motor 3** = e.g. 4TES-8, for medium temperature applications and R134a

For more information concerning the application range use the "Limits" button.

### Operation modes 4VES-7 to 6FE-44 and 44JE-30 to 66FE-88 with R407F/R407A/R22

CIC = liquid injection with low temperature application, suction gas cooled motor.

### ASERCOM certified performance data

The Association of European Refrigeration Component Manufacturers has implemented a procedure of certifying performance data. The high standard of these certifications is assured by:

- \* plausibility tests of the data performed by experts.
- \* regular measurements at independent institutes.

These high efforts result in the fact that only a limited number of compressors can be submitted. Due to this not all BITZER compressors are certified until now. Performance data of compressors which fulfil the strict requirements may carry the label "ASERCOM certified". In this software you will find the label at the respective compressors on the right side below the field "result" or in the print out of the performance data. All certified compressors and further information are listed on the homepage of ASERCOM.

### Condensing capacity

The condensing capacity can be calculated with or without heat rejection. This option can be set in the menu Program  Options. The heat rejection is constantly 5% of the power consumption. The condensing capacity is to be found in the line Condensing cap. (with HR) resp. Condensing capacity.

### Data for sound emission

Data based on 50HZ application (IP-units 60Hz) and R404A if not declared.

Sound pressure level: values based on free field area conditions with hemispherical sound emission in 1 meter distance.

### General remarks regarding sound data

Listed sound data were measured under testing conditions in our laboratory. For this purpose the free-standing test sample is mounted on a solid foundation plate and the pipework is connected vibration-free to the largest extend possible. Suction and discharge lines are fixed in a flexible configuration, such that a transmission of vibrations to the environment can be largely excluded. In real installations considerable differences might be observed, compared to the measurements in the laboratory. The airborne sound emitted by the compressor can be reflected from surfaces of the system and this may increase the airborne sound level measured close to the compressor. Vibrations caused by the compressor are also transferred to the system by the compressor feet and piping depending on the damping ratio of the fixings. Thus, the vibrations can induce other components to such an extent that these components contribute to an increase in airborne sound emission. If required, the transfer of vibrations to the system can be minimized by suitable fixing and damping elements.

### Legend of connection positions according to "Dimensions":

- 1 High pressure connection (HP)
- 2 Connection for discharge gas temperature sensor (HP) (for 4VE(S)-6Y .. 4NE(S)-20(Y) connection for CIC sensor as alternative)
- 3 Low pressure connection (LP)
- 4 CIC system: injection nozzle (LP)
- 4b Connection for CIC sensor
- 4c Connection for CIC sensor (MP / operation with liquid subcooler)
- 5 Oil fill plug
- 6 Oil drain
- 7 Oil filter (magnetic screw)
- 8 Oil return (oil separator)
- 8\* Oil return with NH3 and insoluble oil
- 9 Connection for oil and gas equalization (parallel operation)
- 9a Connection for gas equalization (parallel operation)



- 9b Connection for oil equalization (parallel operation)
  - 10 Oil heater connection
  - 11 Oil pressure connection +
  - 12 Oil pressure connection –
  - 13 Cooling water connection
  - 14 Intermediate pressure connection (MP)
  - 15 Liquid injection (operation without liquid subcooler and with thermostatic expansion valve)
  - 16 Connection for oil monitoring (opto-electrical oil monitoring "OLC-K1" or differential oil pressure switch "Delta-PII")
  - 17 Refrigerant inlet at liquid subcooler
  - 18 Refrigerant outlet at liquid subcooler
  - 19 Clamp space
  - 20 Terminal plate
  - 21 Maintenance connection for oil valve
  - 22 Pressure relief valve to the atmosphere (discharge side)
  - 23 Pressure relief valve to the atmosphere (suction side)
  - 24 IQ MODULE
  - SL Suction gas line
  - DL Discharge gas line
- Dimensions can show tolerances according to EN ISO 13920-B.